

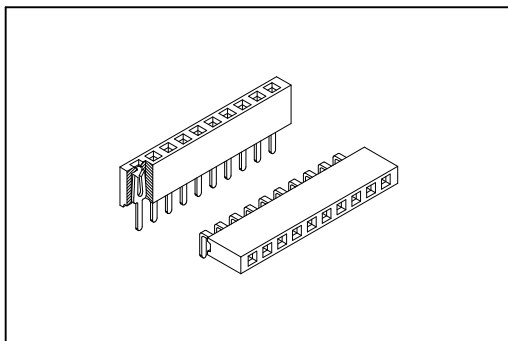

2042 Series

P.C.B. Socket 2.54mm(0.100")



Material:

Housing: Thermoplastic Polyester Glass Filled UL94V-0.

Contacts: Copper Alloy.

Electrical Characteristics:

Current Rating: 2 A.

Dielectric Withstanding Voltage: AC 1000V.

Insulator Resistance: 1000M Ω min.

Contact Resistance: 20m Ω max.

Operating Temperature: -55°C~+105°C.

Features:

- * Available in Straight, Right Angle & Press Fit.
 - * Low profile 5.70mm (0.224").
 - * Mates with 0.64mm (0.025") square pin.
 - * Tuning fork contacts offer lower cost for competitive market.
 - * Additional plating options available.
- Mates with: 2011, 2012, 2015.

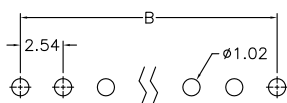
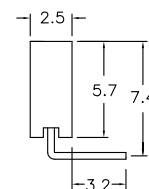
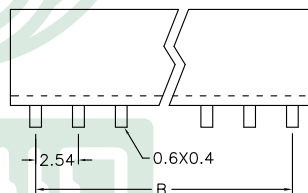
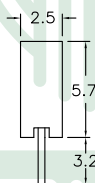
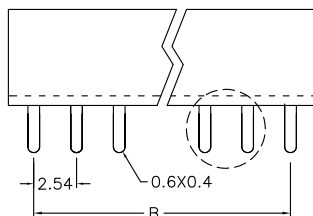
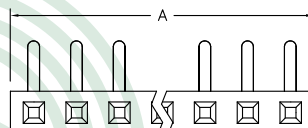
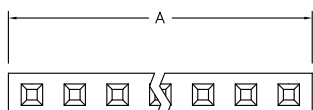

P.C. Board Layout

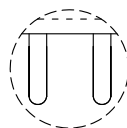

Dip Type

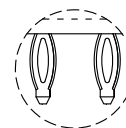

Press Fit Type

Position Dimension	2 Thru 40
A	2.54 X No. of Positions
B	2.54 X No. of Positions - 2.54

Ordering information

2042- Series **1** Single Row **X** **40** No. of Pin Per Row **G** G: Gold Plated **00** 00: G/F **S** S: Straight R: Right Angle **P** Blank: Dip Type P: Press Fit Type **A** A: Tray Package B: Bulk Package