

REV.	SPECIFICATION	ECN NO.	APPD.
R4		ECN241210	

Material and Plating:

Housing: LCP, UL94V-0, Black.
 Contacts: Phosphor Bronze
 Gold Plated on Contact Area and 80u" Min Tin Plated on Solder Tail over Nickel 50 u" Min.
 Counterweight: Brass
 Latches: Brass

Electrical Characteristics:

Current Rating: 1.4 AMP.
 Dielectric Withstanding Voltage: AC 900V For 1 Minute.
 Insulation Resistance: 50000MΩ min.
 Contact Resistance: 25mΩ max.
 Operating Temperature: -55°C~+125°C.

***RoHS Compliant**

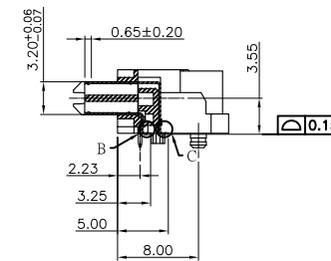
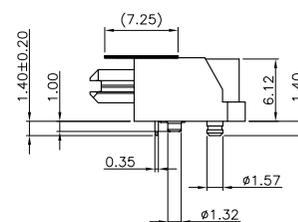
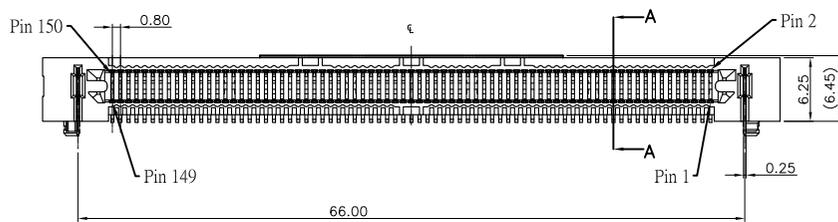
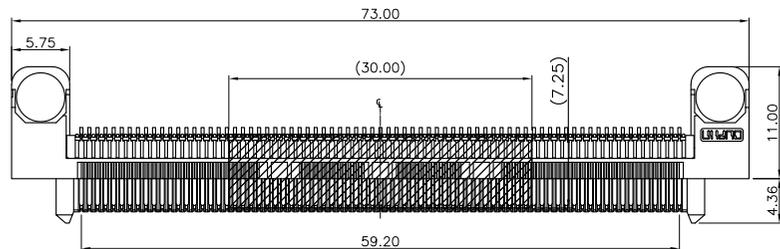
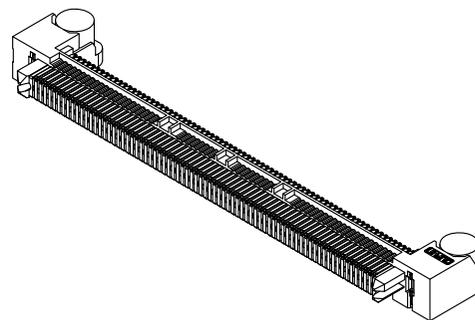

Section A-A

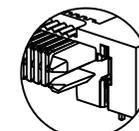

Type lock

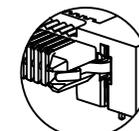

Type1 lock

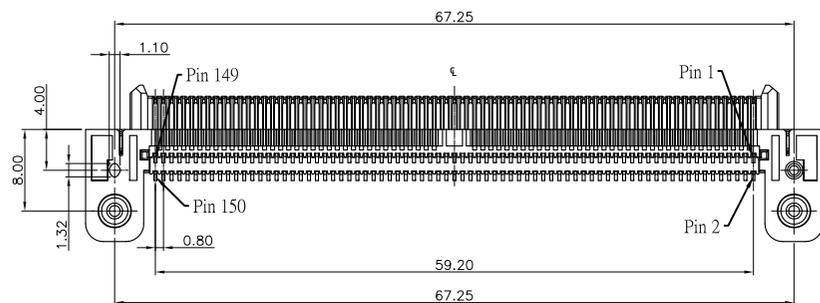

2386- 1 2 X 75 C 3 D 3 x M L T -S
 Series
 1: Male Right Angle
 Double Row
 Position Per Row
 C: Selective Gold Plated
 3: 10u"
 7: 30u"
 D: SMD Type
 Code3
 S: Mylar
 Blank: W/O Mylar
 T: Tape&Reel Package
 L: Type lock
 L1: Type1 lock
 M: Metal Post
 Blank: W/O Metal Post
 Blank: Signal Pin to the Top distance 0.65mm
 Ground Pin to the Top distance 0.65mm
 A: Signal Pin to the Top distance 1.35mm
 Ground Pin to the Top distance 0.65mm

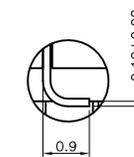

Detail B
Scale 5:1

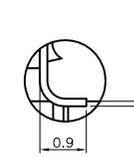

Detail C
Scale 5:1

Tolerances	Dwg No.	2386-D0000-011	Title:		OUPIN ELECTRONIC(KUNSHAN) CO., LTD. P/N: 2386-12X75C3D3xMLT-S	
x. = ±0.50	Projection		2386 Series			
.x = ±0.25	Unit	mm	Scale	1:1		
.xx = ±0.15	Drawn By	WP 12/02'24	Male Right Angle			
			SHEET	1/2	Ver.No.	R4

REV.	SPECIFICATION	ECN NO.	APPD.
R4		ECN210625	

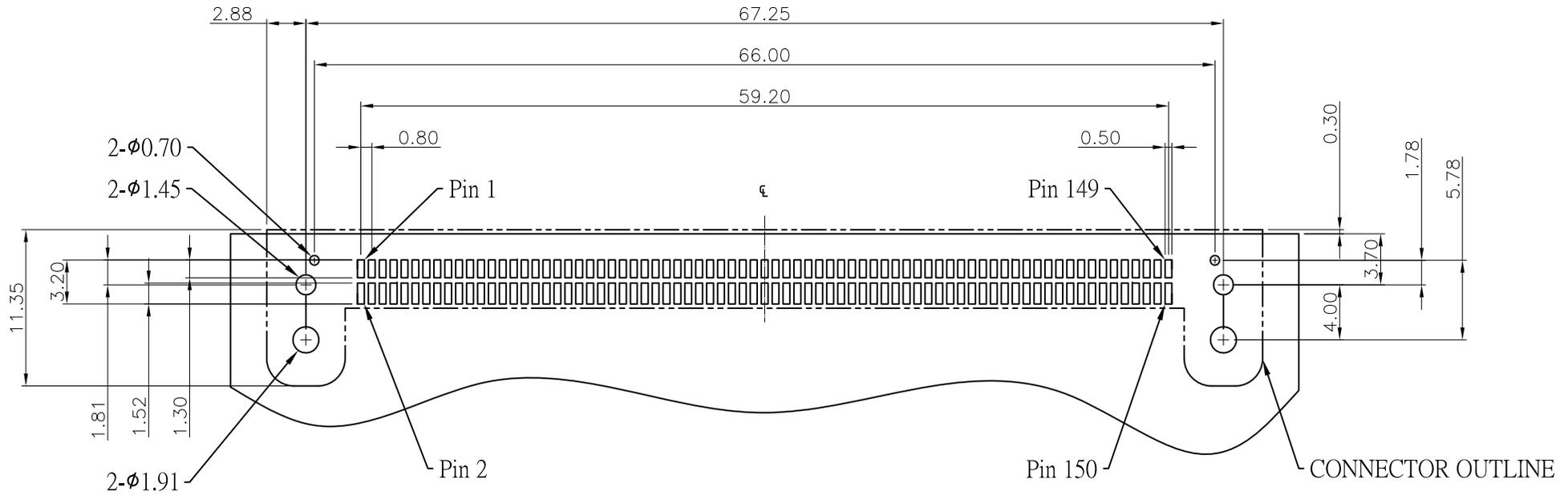

Recommended PCB Layout
(Tolerance : ± 0.05)

Tolerances	Dwg No.	2386-D0000-011	
x. = ± 0.50	Projection		
.x = ± 0.25	Unit	mm	Scale 1:1
.xx = ± 0.15	Drawn By	WP 12/02'24	

Title: 2386 Series
Male Right Angle

OUPIN ELECTRONIC(KUNSHAN) CO., LTD.			
P/N: 2386-12X75C3D3xMLT-S			
SHEET	2/2	Ver.No.	R4