

REV.	SPECIFICATION	ECN NO.	APPD.
R4		ECN140649	

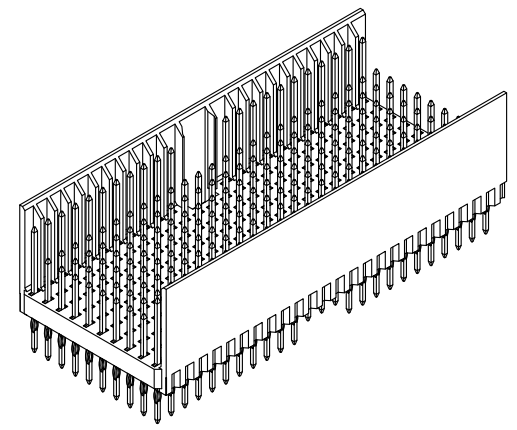
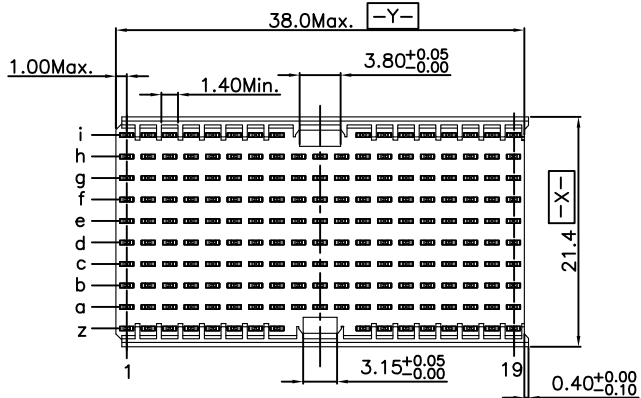

Material:
Housing: Thermoplastic Polyester Glass Filled UL94V-0.
Contacts: Copper Alloy.

Electrical Characteristics:
Current Rating: 1 AMP.
Dielectric Withstanding Voltage: AC 750V For 1 minute.
Insulator Resistance: 10000MΩ min.at DC 500V.
Contact Resistance: 20mΩ max.at DC 100mA.
Operating Temperature: -55°C ~ +125°C.

***RoHS Compliant**

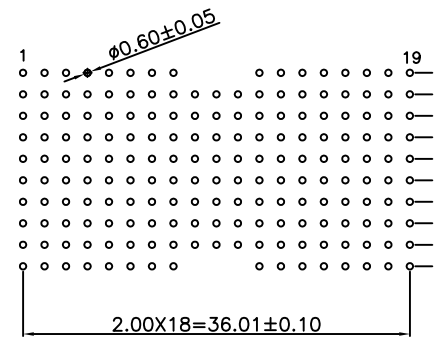
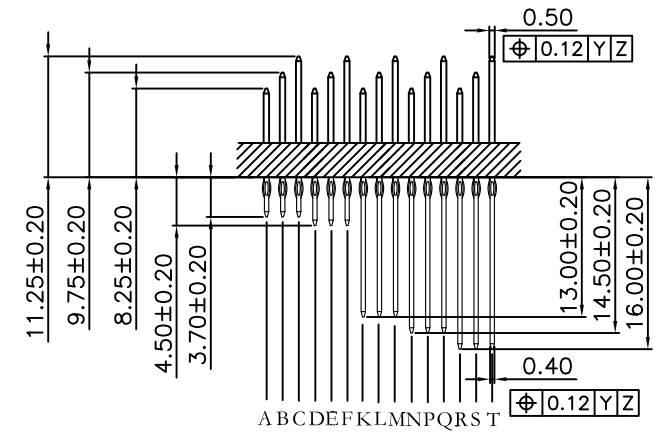
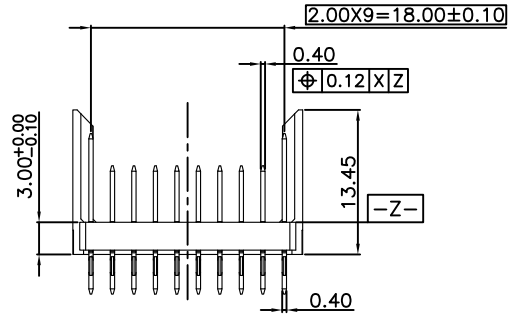
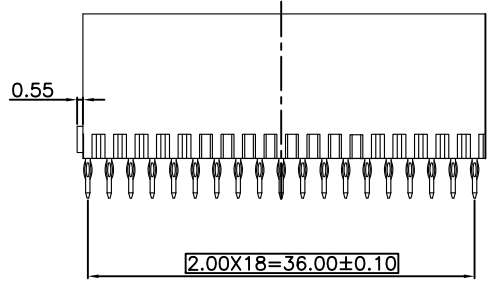

9111- 10 1 DE 184 x C Cxx U
Series—
10Row—
1: Male—
DE: Type DE—
Housing Type—
Signal Pin(a~h Row)—
x: A~T Contact—
Shield Pin(i,z Row)
C:C Contact
Blank:Without
Shield Pin

U: Tube Package
Cxx: Dip Tin Contact Gold
10: 10u"
30: 30u"
CB30: Dip Tin
Contact Au+Pd/Ni
30: 30u"

P.C. Board Layout
(Top View)

Tolerances	Dwg. No.	9111-D0000-018		Title:	
x = ±0.50	Projection	⊕ ◀		9111 Series 2.00 Hard Metric Connectors Male Type DE-19	
.x = ±0.25	Unit	mm	Scale		1:1
.xx = ±0.15	Drawn By	WP 06/27'14			

OUPIN			
OUPIN ELECTRONIC(KUNSHAN) CO., LTD.			
P/N: 9111-101DE184xCCxxU			
SHEET	1/2	Ver.No.	R4

REV.	SPECIFICATION	ECN NO.	APPD.
R4		ECN140649	

CONTACT LAYOUT

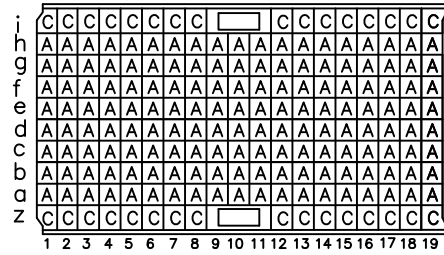

9111-101DE184ACCxxU

CONTACT LAYOUT

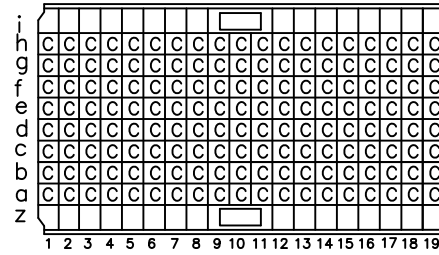

9111-101DE184CCxxU

CONTACT LAYOUT

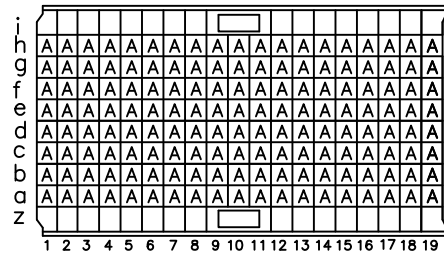

9111-101DE184ACxxU

Tolerances	Dwg. No.	9111-D0000-018	
x = ±0.50	Projection		
.x = ±0.25	Unit	mm	Scale 1:1
.xx = ±0.15	Drawn By	WP 06/27'14	

Title:

9111 Series
2.00 Hard Metric
Connectors Male
Type DE-19



OUPIIN ELECTRONIC(KUNSHAN) CO., LTD.

P/N: 9111-101DE184xCCxxU

SHEET	2/2	Ver.No.	R4
-------	-----	---------	----