

REV.	SPECIFICATION	ECN NO.	APPD.
R8		ECN170312	

Material:
Housing: Thermoplastic Polyester Glass Filled UL94V-0.
Contacts: Copper Alloy.
Electrical Characteristics:
Current Rating: 1 AMP.
Dielectric Withstanding Voltage: AC 750V For 1 minute.
Insulator Resistance: 10000MΩ min. at DC 500V.
Contact Resistance: 20mΩ max. at DC 100mA.
Operating Temperature: -55°C ~+125°C .
***RoHS Compliant**

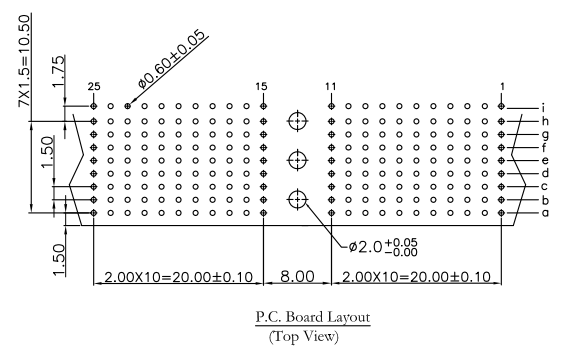
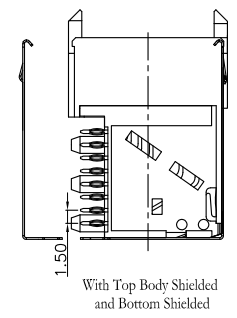
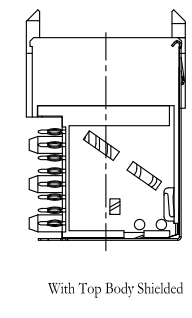
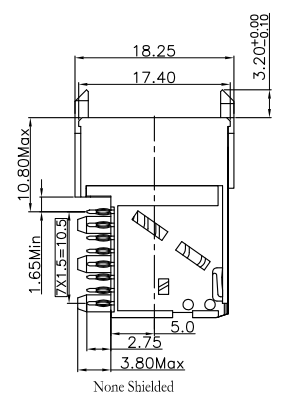
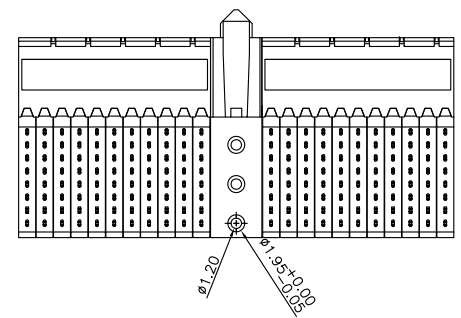
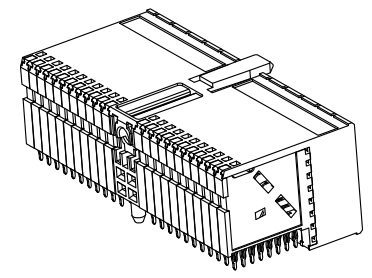
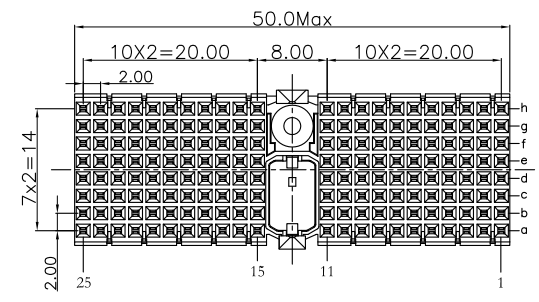

9111- 10 2 D 176 x CB 30 U
Series — 10Row — 2: Female — D: Type D — Position — 1: None Shielded — 2: Top Body Shielded — 3: Top Body Shielded and Bottom Shielded (Package Separately)
U: Tube package
30: 30 u"
CB: Dip Tin Plated Contact Au+Pd/Ni Plated

Tolerances	Dwg. No.	9111-D0000-007	Title:	9111 Series Hard Metric Connector Female Right Angle Type D	OUPIN OUPIN ELECTRONIC(KUNSHAN) CO., LTD.	
x = ±0.5	Projection					
.x = ±0.25	Unit	mm			Scale	1:1
.xx = ±0.15	Drawn By	zbs 03/17'17			SHEET	1/1