

REV.	SPECIFICATION	ECN NO.	APPD.
R1			

Material:
Housing: Thermoplastic Polyester Glass Filled UL94V-0
Contacts: Copper Alloy.

Electrical Characteristics:
Current Rating: 1 AMP.
Dielectric Withstanding Voltage: AC 750V For 1 minute.
Insulator Resistance: 10000MΩ min.at DC 500V.
Contact Resistance: 20mΩ max.at DC 100mA.
Operating Temperature: -55°C ~ +125°C.

***RoHS Compliant**

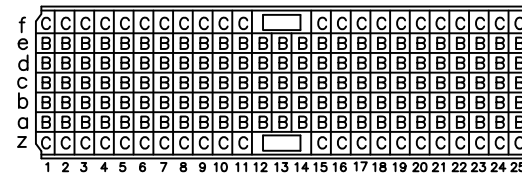
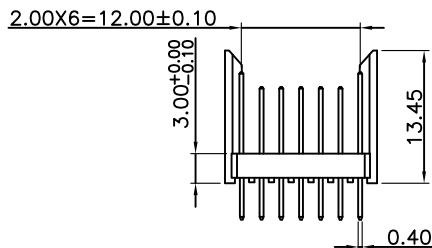
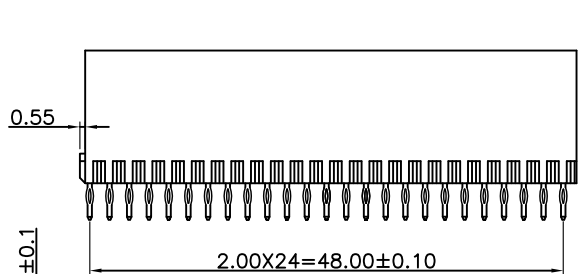
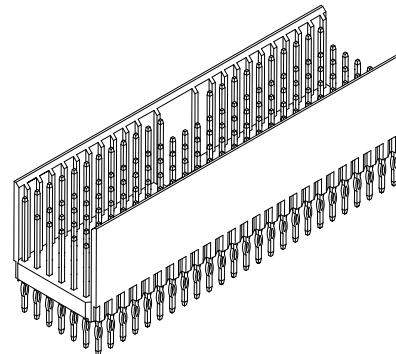
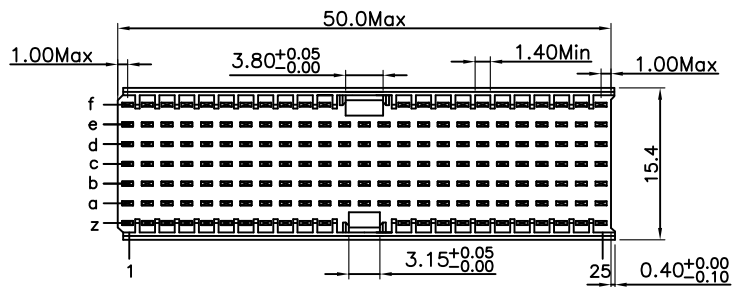

CONTACT LAYOUT

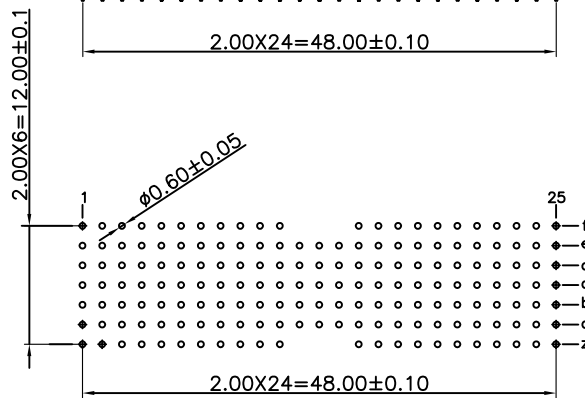

P.C. Board Layout
(Top View)

9111- 7 1 AB 169 D C xx U
Series | 7Row | 1: Male | AB: Type AB | Housing Type | D: D Option | U: Tube Package | C: Dip Tin | Contact Gold | G: Gold

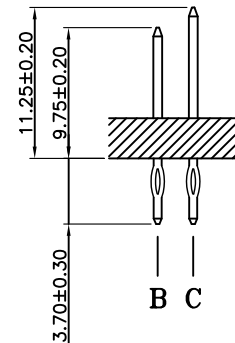

Tolerances	Dwg. No.	9111D71071		Title:	
x = ±0.5	Projection			9111 Series 2.00 Hard metric Connectors Male Type AB-25	
.x = ±0.25	Unit	mm	Scale		1:1
.xx = ±0.15	Drawn By	Zhu QL 08/15'12			

OUPIN			
OUPIN ELECTRONIC(KUNSHAN) CO., LTD.			
P/N: 9111-71AB169DCxxU			
SHEET	1/1	Ver.No.	R1