

REV.	SPECIFICATION	ECN NO.	APPD.
A5	修改料號.P.C.B尺寸和增加電氣特性	11/14'05	

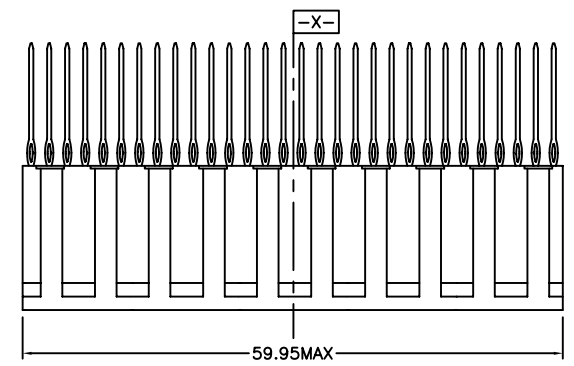
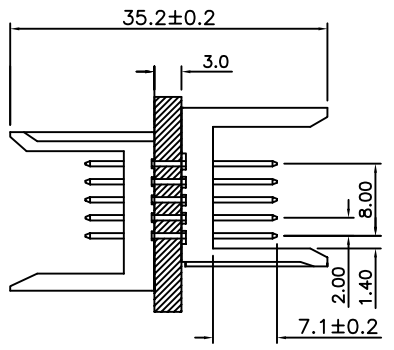

(A5)

Material:
Housing: Liquid Crystal Polymer(LCP) UL94V-0.
Contacts: Phosphor Bronze.

Electrical Characteristics:
Current Rating: 1 AMP.
Dielectric Withstanding Voltage: AC 1000V For 1 minute.
Insulator Resistance: 1000MΩmin. at DC 500V.
Contact Resistance: 30mΩmax. at DC 100mA.
Operating Temperature: -65°C ~ +125°C.

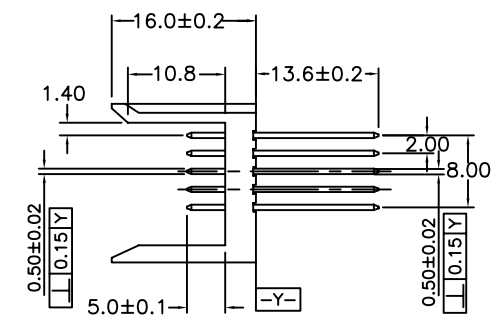
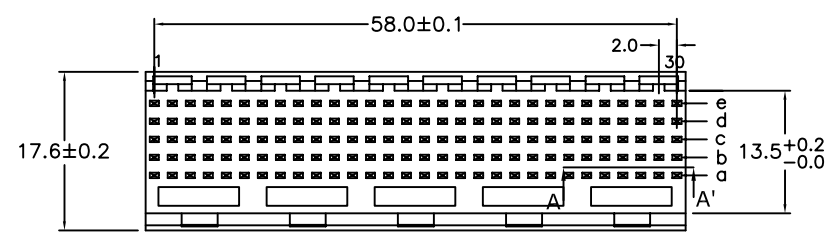
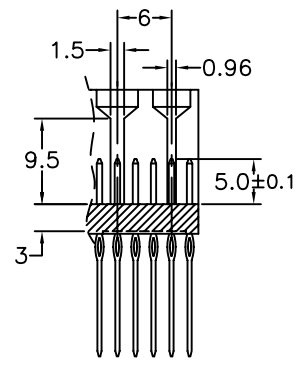

Section A-A'

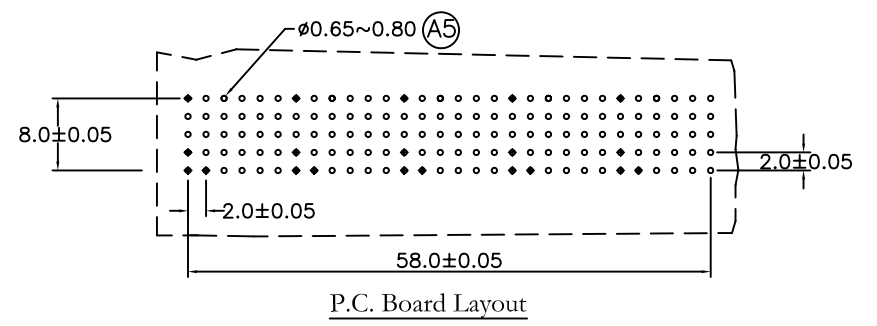
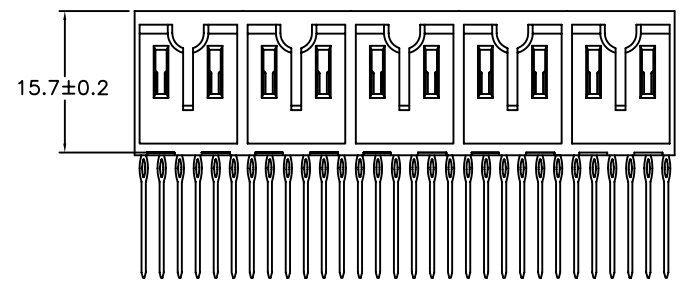

Tolerances	Drawn No.	9111D51067	
x = ±0.5	Projection	⊕ ⊖	
.x = ±0.25	Unit	mm	Scale 1:1
.xx = ±0.13	Drawn By	YUXQ11/14'05	

Title: 9111 Series
H.D. Male 2.0mm
Futurebus(+) 5 Rows
Straight Type

OUPIN			
OUPIN ELECTRONIC(KUNSHAN) CO., LTD.			
P/N: 9111-51150JG10PU (A5)			
SHEET	1/1	Ver.No.	A5