

REV.	SPECIFICATION	ECN NO.	APPD.
R4		ECN121230	

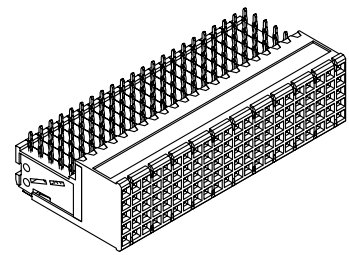
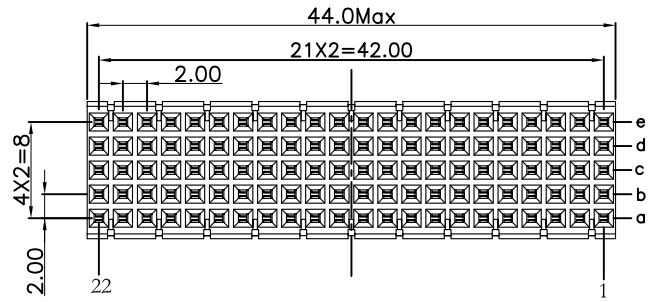

Material:

Housing: Thermoplastic Polyester Glass Filled UL94V-0.
 Contacts: Copper Alloy

Electrical Characteristics:

Current Rating: 1 AMP.
 Dielectric Withstanding Voltage: AC 750V For 1 minute.
 Insulator Resistance: 10000MΩ min. at DC 500V.
 Contact Resistance: 20mΩ max. at DC 100mA.
 Operating Temperature: -55°C ~+125°C .

***RoHS Compliant**

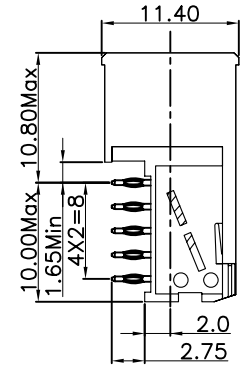
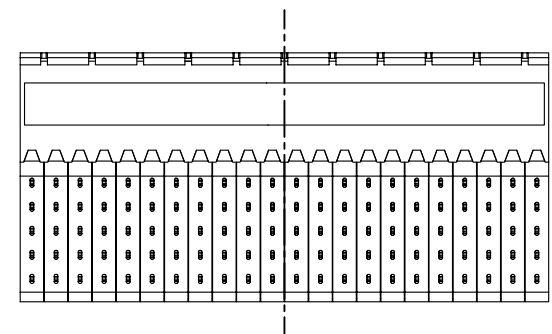

None Shielded

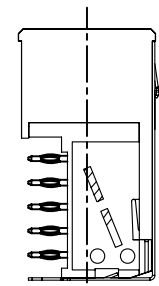

With Top Body Shielded

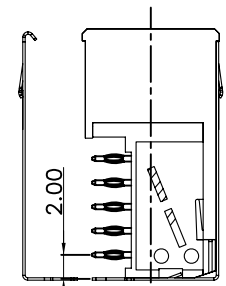

With Top Body Shielded and Bottom Shielded

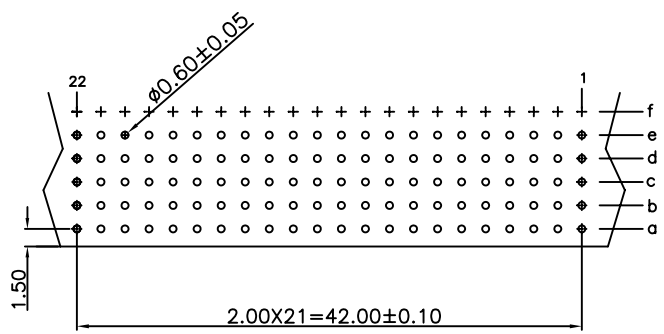

P.C. Board Layout
(Top View)

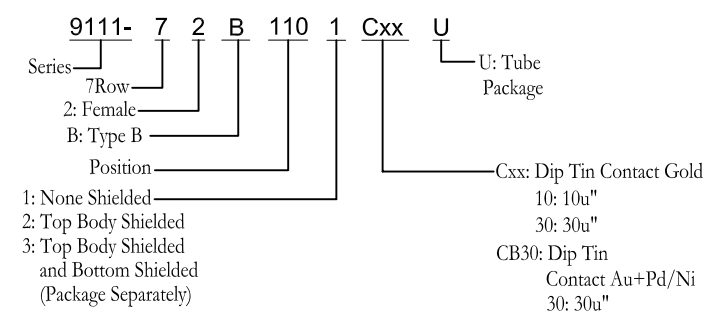

Tolerances	Dwg. No.	9111D72003		Title:	9111 Series Hard Metric Connector Female Right Angle Type B-22			 OUPIN ELECTRONIC(KUNSHAN) CO., LTD. P/N: 9111-72B110xCxxU			
x = ±0.5	Projection										
.x = ±0.25	Unit	mm	Scale	1:1							
.xx = ±0.15	Drawn By	CQ 12/14'12									