

REV.	SPECIFICATION	ECN NO.	APPD.
R3		ECN171150	

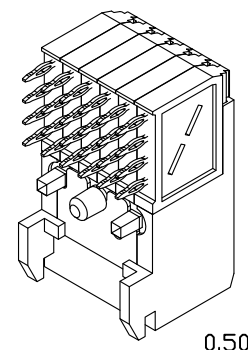
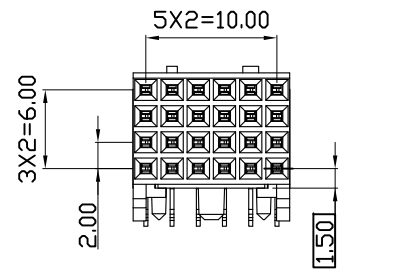

Material:

Housing: High Temperature Plastic UL94V-0
Contacts: Copper Alloy.
 10u" Au+Pd/Ni on Contact Area and 80u" Min Tin Plated on Solder Tail over nickel 50u" Min .

Electrical Characteristics:

Current Rating: 1 AMP.
Dielectric Withstanding Voltage: AC 1000V For 1 minute.
Insulator Resistance: 1000MΩ min. at DC 500V.
Contact Resistance: 30mΩ max. at DC 100mA.
Operating Temperature: -55°C ~+125°C .

***RoHS Compliant**

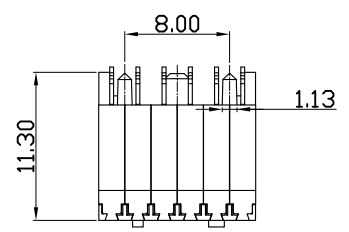
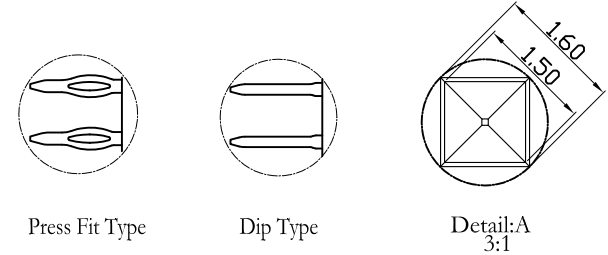
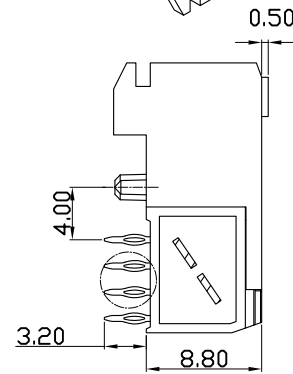
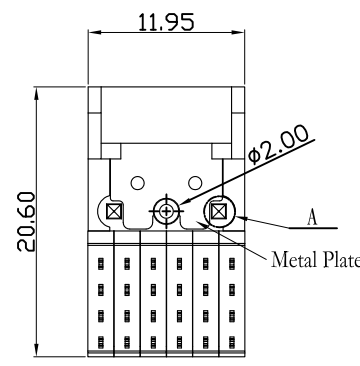

9111-A 4 2 24 1 1 CB xx D T
 Series 4Row 2: Female Position 1: Dip Length 0: None Metal Plate 1: With Metal Plate
 U: Tube Package T: Tape Reel Package
 D: Dip Type P: Press Fit Type
 10: 10 u" 30: 30 u"
 C: Selective Gold Plated CB: Dip Tin Contact Au+Pd/Ni

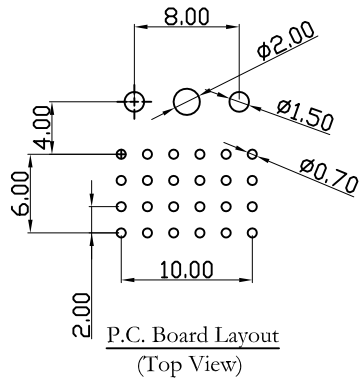

Tolerances	Drawn No. 9111-D0000-022	Title: 9111 Series	
x = ±0.5	Projection	Hard Metric Connector	
.x = ±0.25	Unit mm	Scale 1:1	 OUPIIN ELECTRONIC(KUNSHAN) CO., LTD. P/N: 9111-A42241xCBxxDT
.xx = ±0.15	Drawn By YS 11/22'17	Female Right Angle Type	

SHEET	1/1	Ver.No.	R3
--------------	-----	----------------	----