

REV.	SPECIFICATION	ECN NO.	APPD.

Material:
Housing: Thermoplastic Polyester Glass Filled UL94HB.
Screw: Metal.
***RoHS Compliant**

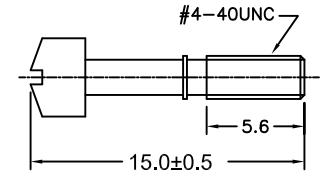

HW-S120EN00

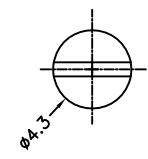
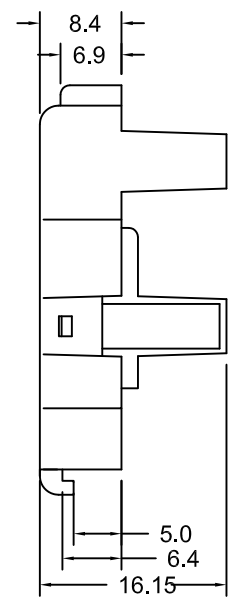
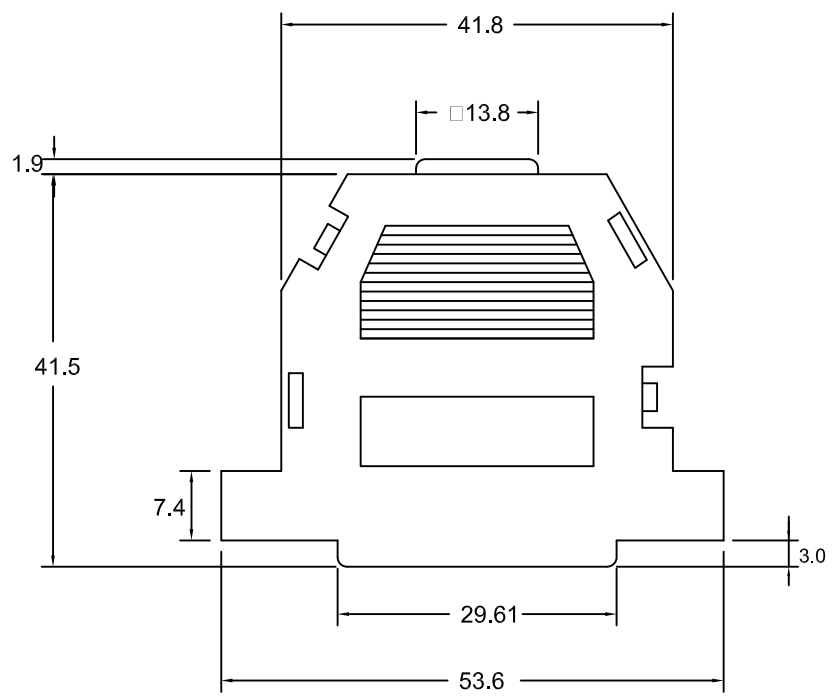
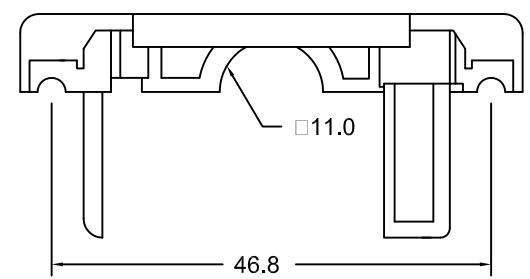
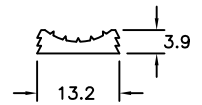
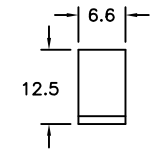
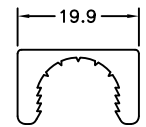

DP- 25 Q Y B
Series Position Q: Quick Y: Grey B: Bulk Package
 Lock B: Black P: Individual Package
 C: Chrome
 (Plastic Metallized)

Tolerances	Dwg. No.	DP00D00009	Title:		DP Cover	OUPIN					
x = ±0.80	Projection					OUPIN ELECTRONIC(KUNSHAN) CO., LTD.					
.x = ±0.50	Unit	mm				Scale	1:1	P/N: DP-25QYB			
.xx = ±0.35	Drawn By	Vic Lyu11/09'15				0741	SHEET	1/1	Ver.No.	A5	