

REV.	SPECIFICATION	ECN NO.	APPD.

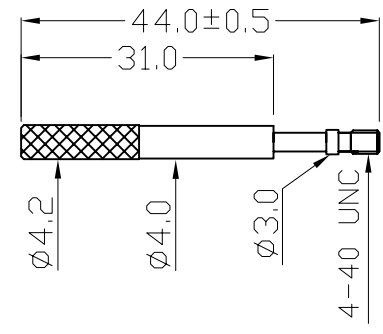

Materials
Housing: ABS UL94HB
Screw: Metal.
***RoHS Compliant**

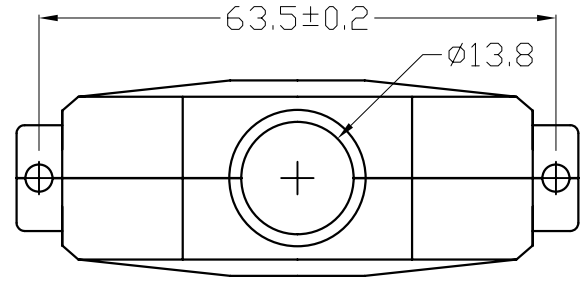
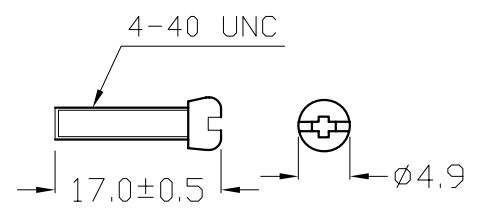
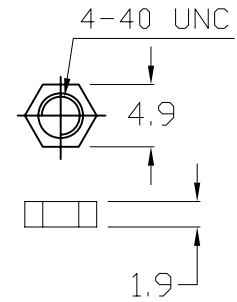
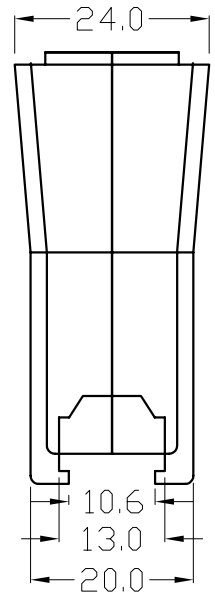
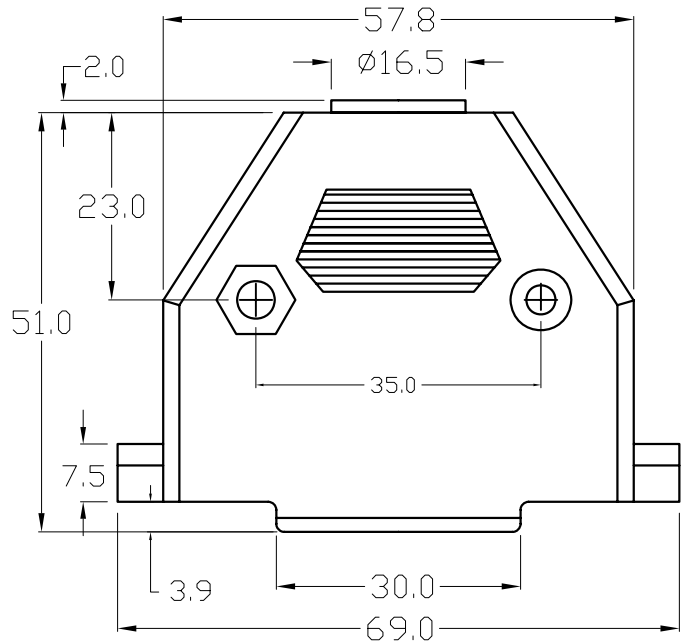
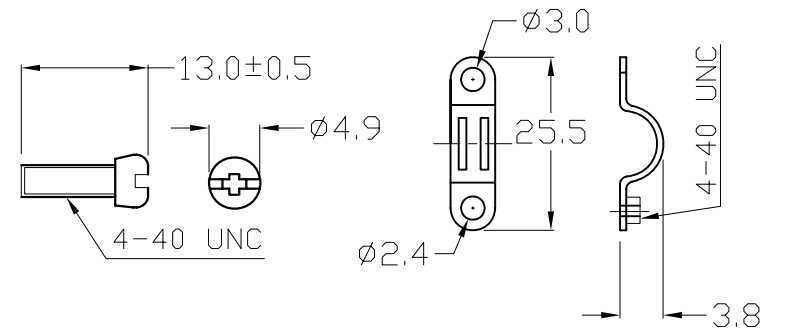

DP- 37 **Y** **SL** **B**
Series Position Y: Grey SL: Long Screw B: Bulk Package
 B: Black
 C: Chrome
 (plastic metallized)
 P: Individual Package

Tolerances	Drawn No.	DP00D00015	Title:		OUPIIN OUPIIN ELECTRONIC(KUNSHAN) CO., LTD. P/N: DP-37YSLB	
x = ±0.8	Projection	⊕ ↗	DP Cover Plastic Hood			
.x = ±0.5	Unit	mm				Scale
.xx = ±0.35	Drawn By	Peggy06/07'11	SHEET	1/1	Ver.No.	A3